

## Features

- 1-1/4" connection.
- Available with non-removable metal stopper.
- For use in non-overflow applications.
- For use with Spun Glass™ Vessels lavatory.



## Codes/Standards











ASME A112.18.2/CSA B125.2

## KOHLER® One-Year Limited Warranty

See website for detailed warranty information.

## Available Colors/Finishes

*Color tiles intended for reference only.*

Color	Code	Description
	CP	Polished Chrome
	SN	Vibrant® Polished Nickel
	AF	Vibrant® French Gold
	PGD	Vibrant® Moderne Polished Gold
	BGD	Vibrant® Moderne Brushed Gold
	G	Brushed Chrome
	BN	Vibrant® Brushed Nickel
	BV	Vibrant® Brushed Bronze
	2BZ	Oil-Rubbed Bronze
	TB	Satin Black
	TT	Titanium

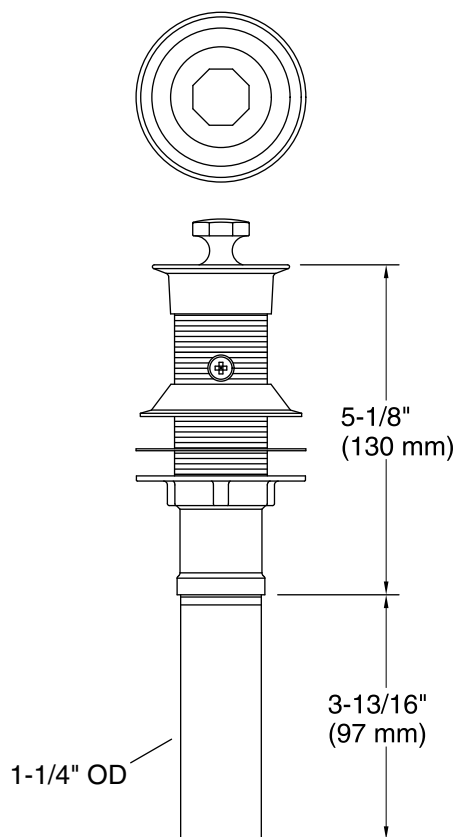

### Technical Information

All product dimensions are nominal.

### Notes

Install this product according to the installation guide.